

# WILKENS<sup>TM</sup>

A Step Ahead<sup>TM</sup>

## WALKING FLOOR<sup>®</sup> TRAILERS

**Wilkins Industries**

**184 South County Road 22**

**Morris, MN 56267**

**320-589-1971**

**800-833-6045**

**320-589-1974fax**

***Presents a PRICE Guide for;***

**KEITH<sup>®</sup> FLOORING and Components**

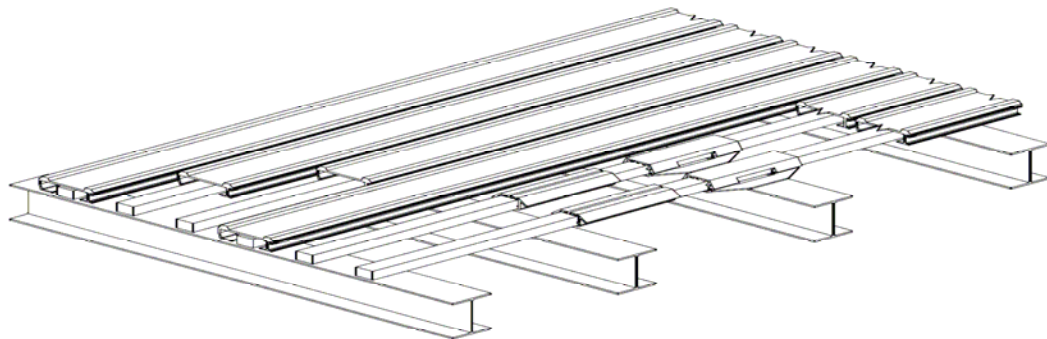

**ORDER ONLINE!!** Pricing is not guaranteed, and can be subject to change at the discretion of our suppliers.

***ORDER PARTS via email 24 HOURS A DAY!***  
***Orders placed after 3:00 pm CST will be filled the following business day. Please include a phone number, and complete delivery address.***

***We offer a discount system based on amount of purchase. Payment terms must be met.***

***Please ask about these discounts, and let Wilkens Industries offer you big savings on you flooring parts needs.***

***These discounts are offered to all customers and dealers, but only apply if payment terms are met. Invoice must be pre-paid before shipping, paid with credit card at time of order, or paid in full within 10 days of ordering if customer has pre-approved credit with Wilkens Industries. We reserve the right to request down payment on larger orders with approved credit accounts. Discounts will be based on LIST PRICE of the dollar amount purchased. These discounts do not include applicable taxes, freight inbound or outbound , and does not include the purchases of Trailers, Trucks ,Power Flip units, Tarps ,or tarp components.***

***Please Contact .....***

[keithk@wilkens-ind.com](mailto:keithk@wilkens-ind.com)

[scottb@wilkens-ind.com](mailto:scottb@wilkens-ind.com)

---

---

***PRICING ON FLOOR SLATS IS PER FOOT,  
and attached pricing is only a guide.***

***SEAL, FRONT FILLER, AND, REAR  
WEAR STRIPS ARE ADDITIONAL  
EXPENSE TO THE PRICE PER  
FOOT!! These can be configured many  
different ways.***

***Please contact us to get an accurate  
and current price for floor slats and  
components!***

**WILKENS INDUSTRIES**

**320-589-1971**

**800-833-6045**

**320-589-1974 – fax**

**[keithk@wilkens-ind.com](mailto:keithk@wilkens-ind.com)**

**[scottb@wilkens-ind.com](mailto:scottb@wilkens-ind.com)**

**www.wilkens-ind.com**

**KEITH®**

**FLOORING &**

**COMPONENTS**

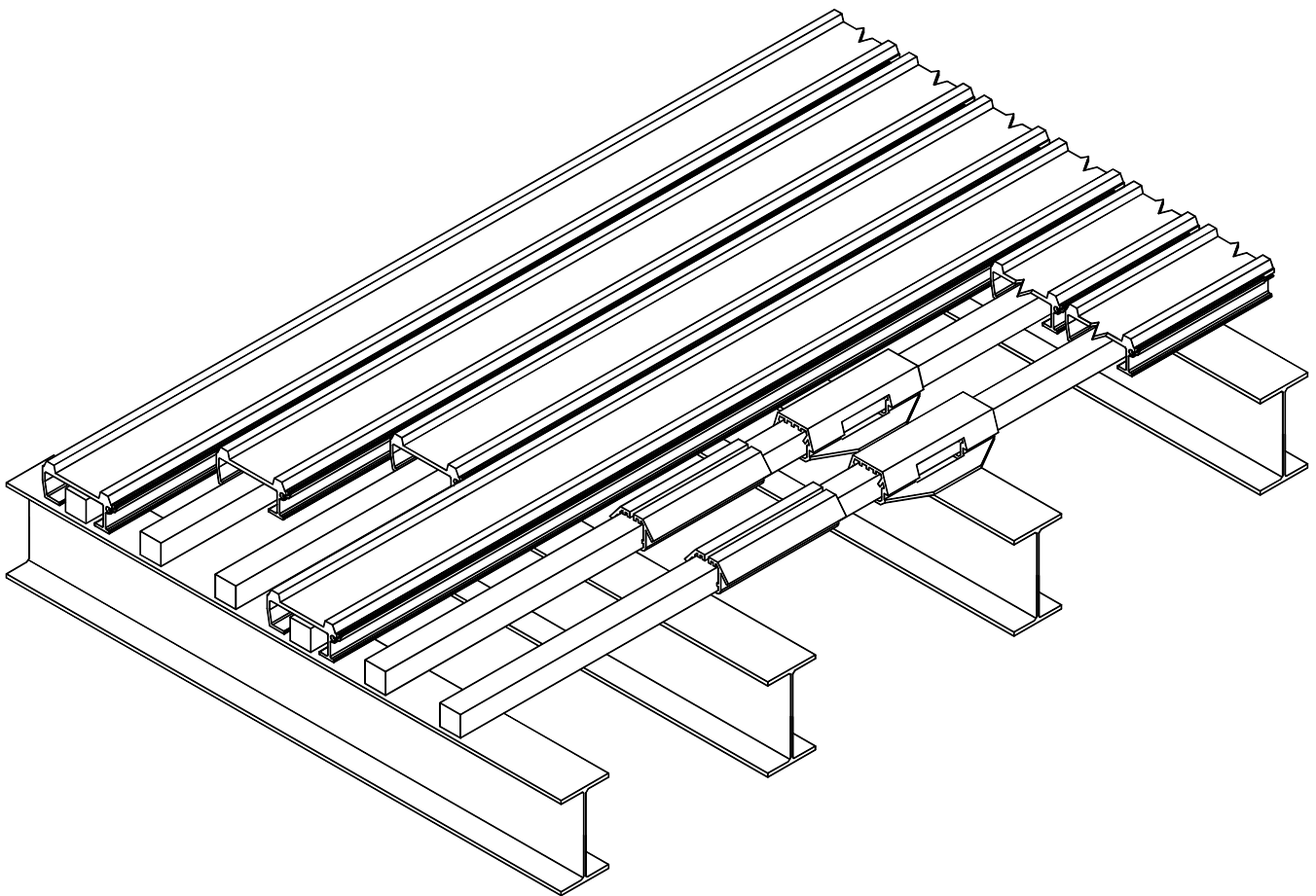

**Section 8**

3.5" Slats (1212 Seal) .....	8.4
6.0" & 7.0" Slats (1212 Seal).....	8.6
3.5", 6.0" & 7.0" Slats (1207 Seal) .....	8.8
Leak Proof Slat/Subdeck Combination .....	8.10
Hammer Seal Slats/Pressure Seal® Slats .....	8.11
Seals, Side Seals, Subdecks & Plugs.....	8.12
Bearings, Hold Downs & "T" Blocks.....	8.14
Fasteners .....	8.16
Bolt Plates.....	8.18
Seal Installation Instructions .....	8.19
Trimming A Floor Slat (After Seal Is Installed).....	8.23

KEITH®, WALKING FLOOR®, Impact® and Pressure Seal® are registered trademarks of KEITH Mfg. Co.

Single Seal

Double Seal

Single Seal

Double Seal

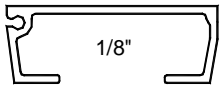

2216

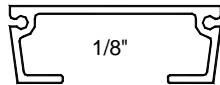

2217

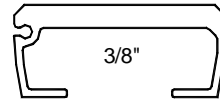

2199  
(1977)

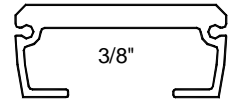

2200

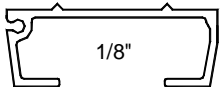

2185  
(1968)

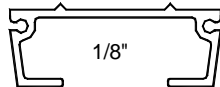

2186

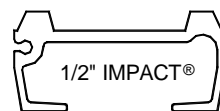

2295  
(1914-3.5)

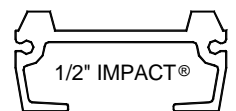

2296

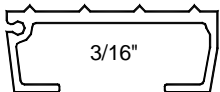

2188  
(2180)

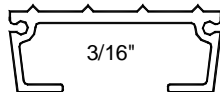

2189

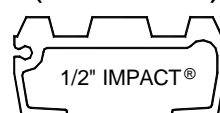

2299  
(1914-3.5 CWS)

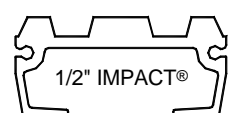

2300

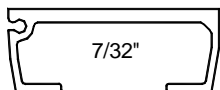

2203  
(1976)

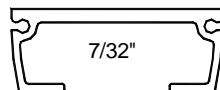

2204



2297  
(1841-3.5)



2298

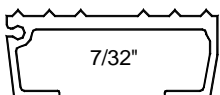

2190  
(1975)

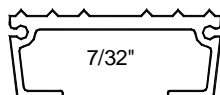

2191

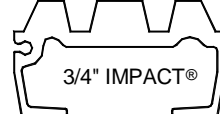

2301  
(1841-3.5 CWS)



2302

## Parts List

ID#	DESCRIPTION	PART NUMBER*
2216	Slat 3.5" 1/8" Smooth	8222160000
2217	Slat 3.5" 1/8" Smooth DS	8222170000
2185	Slat 3.5" 1/8" 2 Ridge	8221850000
2186	Slat 3.5" 1/8" 2 Ridge DS	8221860000
2188	Slat 3.5" 3/16" 4 Ridge	8221880000
2189	Slat 3.5" 3/16" 4 Ridge DS	8221890000
2203	Slat 3.5" 7/32" Smooth	8222030000
2204	Slat 3.5" 7/32" Smooth DS	8222040000
2190	Slat 3.5" 7/32" 6 Ridge	8221900000
2191	Slat 3.5" 7/32" 6 Ridge DS	8221910000
2199	Slat 3.5" 3/8" Smooth	8221990000
2200	Slat 3.5" 3/8" Smooth DS	8222000000
2295 <sup>(1)</sup>	Slat 3.5" 1914 1/2" Impact <sup>®</sup> Series 1212	8222950000
2296 <sup>(1)</sup>	Slat 3.5" 1913 1/2" Impact <sup>®</sup> Series DS 1212	8222960000
2299 <sup>(2)</sup>	Slat 3.5" 1914 CWS 1/2" Impact <sup>®</sup> Series 1212	8222990000
2300 <sup>(2)</sup>	Slat 3.5" 1913 CWS 1/2" Impact <sup>®</sup> Series DS 1212	8223000000
2297 <sup>(3)</sup>	Slat 3.5" 1841 3/4" Impact <sup>®</sup> Series 1212	8222970000
2298 <sup>(3)</sup>	Slat 3.5" 1890 3/4" Impact <sup>®</sup> Series DS 1212	8222980000
2301 <sup>(4)</sup>	Slat 3.5" 1841 CWS 3/4" Impact <sup>®</sup> Series 1212	8223010000
2302 <sup>(4)</sup>	Slat 3.5" 1890 CWS 3/4" Impact <sup>®</sup> Series DS 1212	8223020000

(1) 2295 & 2296 are replacing 2201 & 2202 starting in 2000.

(2) 2299 & 2300 are replacing 2218 & 2219 starting in 2000.

(3) 2297 & 2298 are replacing 2153 & 2154 starting in 2000.

(4) 2301 & 2302 are replacing 2290 & 2291 starting in 2000.

\*The last four digits in the ten digit part number refers to length in feet and inches (Example: 8222164305 is 43'05" long).

**Single Seal**

**Double Seal**

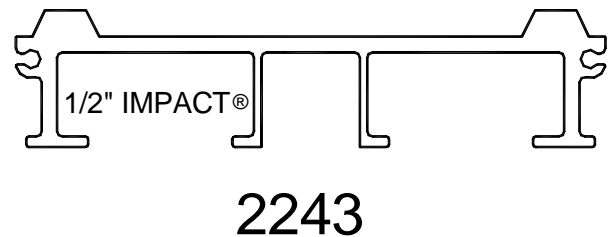
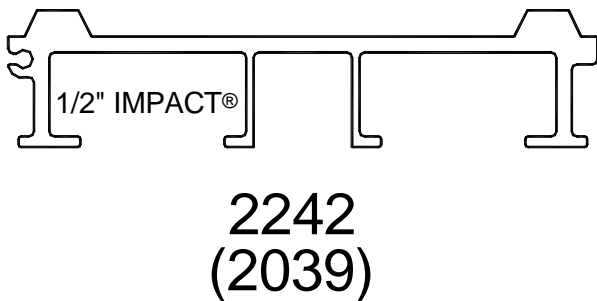
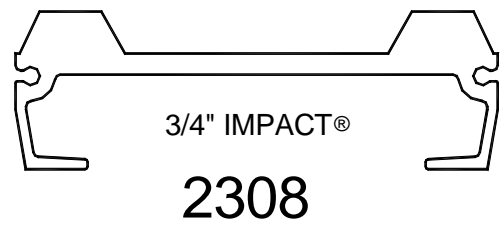
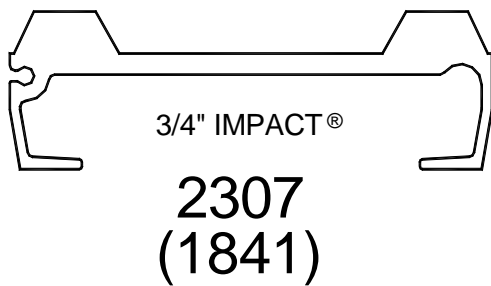
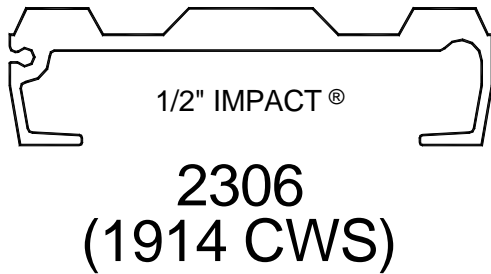
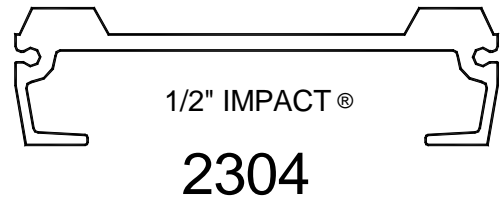
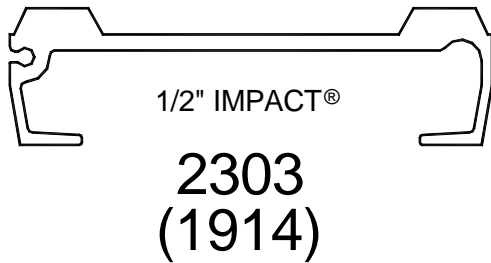

## Parts List

ID#	DESCRIPTION	PART NUMBER*
2303 <sup>(1)</sup>	Slat 6.0" 1914 1/2" Impact <sup>®</sup> Series 1212	8223030000
2304 <sup>(1)</sup>	Slat 6.0" 1913 1/2" Impact <sup>®</sup> Series DS 1212	8223040000
2306 <sup>(2)</sup>	Slat 6.0" 1914 CWS 1/2" Impact <sup>®</sup> Series 1212	8223060000
2305 <sup>(2)</sup>	Slat 6.0" 1913 CWS 1/2" Impact <sup>®</sup> Series DS 1212	8223050000
2307 <sup>(3)</sup>	Slat 6.0" 1841 3/4" Impact <sup>®</sup> Series 1212	8223070000
2308 <sup>(3)</sup>	Slat 6.0" 1890 3/4" Impact <sup>®</sup> Series DS 1212	8223080000
2242	Slat 7.0" 1/2" Impact <sup>®</sup> Series 1212	8222420000
2243	Slat 7.0" 1/2" Impact <sup>®</sup> Series DS 1212	8222430000

(1) 2303 & 2304 are replacing 2052 & 2053 starting in 2000.

(2) 2306 & 2305 are replacing 2174 & 2173 starting in 2000.

(3) 2307 & 2308 are replacing 2037 & 2038 starting in 2000.

\*The last four digits in the ten digit part number refers to length in feet and inches (Example: 8223034305 is 43'05" long).

**Single Seal**

**Double Seal**

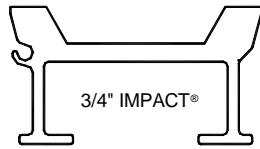

**2153**  
**(1841-3.5)**

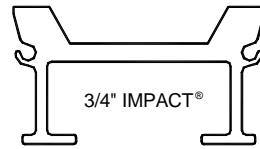

**2154**

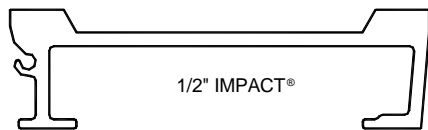

**2052**  
**(1914)**

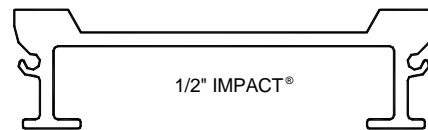

**2053**

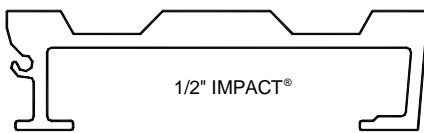

**2174**  
**(1914 CWS)**

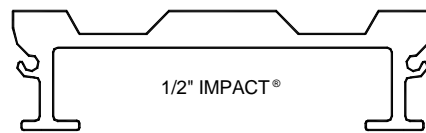

**2173**

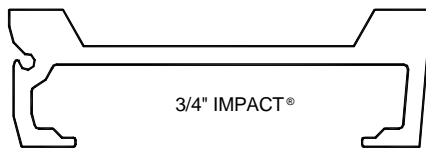

**2037**  
**(1841)**



**2038**

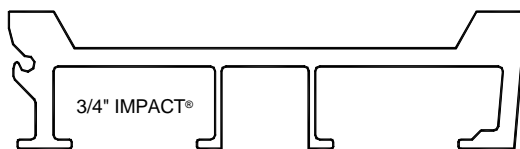

**2031**

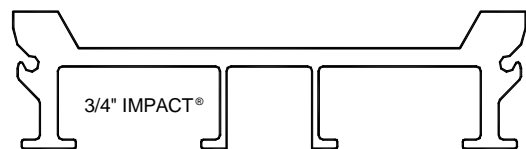

**2032**

## Parts List

ID#	DESCRIPTION	PART NUMBER*
2153	Slat 3.5" 1841 3/4" Impact® Series 1207 <sup>(1)</sup>	8221530000
2154	Slat 3.5" 1890 3/4" Impact® Series DS 1207	8221540000
2052	Slat 6.0" 1914 1/2" Impact® Series 1207	8220520000
2053	Slat 6.0" 1913 1/2" Impact® Series DS 1207	8220530000
2174	Slat 6.0" 1914 CWS 1/2" Impact® Series 1207	8221740000
2173	Slat 6.0" 1913 CWS 1/2" Impact® Series DS 1207	8221730000
2037	Slat 6.0" 1841 3/4" Impact® Series 1207	8220370000
2038	Slat 6.0" 1890 3/4" Impact® Series DS 1207	8220380000
2031	Slat 7.0" 3/4" Impact® Series 1207	8220310000
2032	Slat 7.0" 3/4" Impact® Series DS 1207	8220320000

(1) 1207 seal replaces 1205 seal.

\*The last four digits in the ten digit part number refers to length in feet and inches (Example: 8221534305 is 43'05" long).

## Subdeck

## Slat

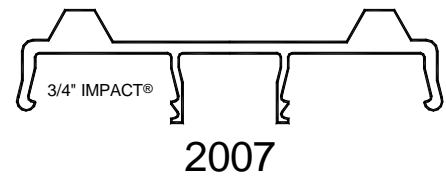
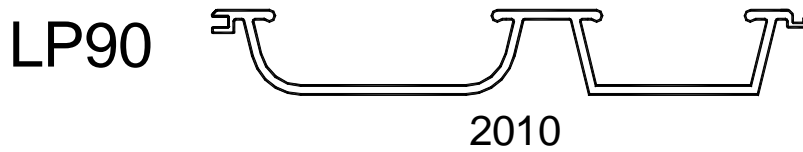
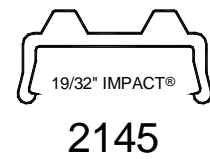
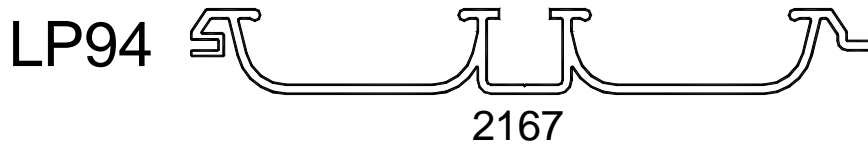

## Parts List

ID#	DESCRIPTION	PART NUMBER*
2167	Subdeck LP94	8221670000
2145	Slat 3.5" LP94 19/32" Impact® Series	8221450000
2010	Subdeck LP90	8220100000
2007	Slat 7.0" LP90 3/4" Impact® Series	8220070000

\*The last four digits in the ten digit part number refers to length in feet and inches (Example: 8221674305 is 43'05" long).

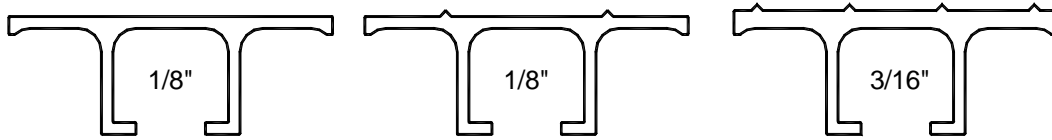

2193

2236

2195

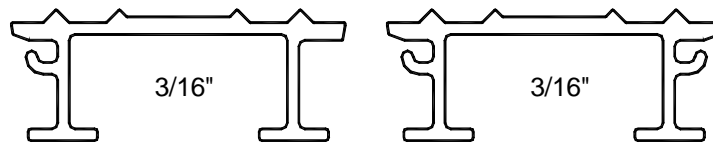

2271

2272

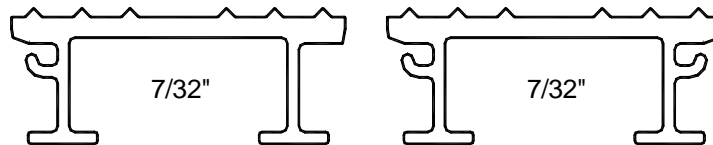

2293

2294

## Parts List

ID#	DESCRIPTION	PART NUMBER*
2193	Slat 3.5" 1/8" Smooth Pressure Seal®	8221930000
2236	Slat 3.5" 1/8" 2 Ridge Pressure Seal®	8222360000
2195	Slat 3.5" 3/16" 4 Ridge Pressure Seal®	8221950000
2271 <sup>(1)</sup>	Slat 3.5" 3/16" 4 Ridge Hammer Seal	8222710000
2272 <sup>(1)</sup>	Slat 3.5" 3/16" 4 Ridge Hammer Seal DS	8222720000
2293 <sup>(2)</sup>	Slat 3.5" 7/32" 6 Ridge Hammer Seal	8222930000
2294 <sup>(2)</sup>	Slat 3.5" 7/32" 6 Ridge Hammer Seal DS	8222940000

(1) 2271 & 2272 are replacing 2166 & 2178 starting in 2000.

(2) 2293 & 2294 are replacing 2181 & 2183 starting in 2000.

\*The last four digits in the ten digit part number refers to length in feet and inches (Example: 8221934305 is 43'05" long).

Seals

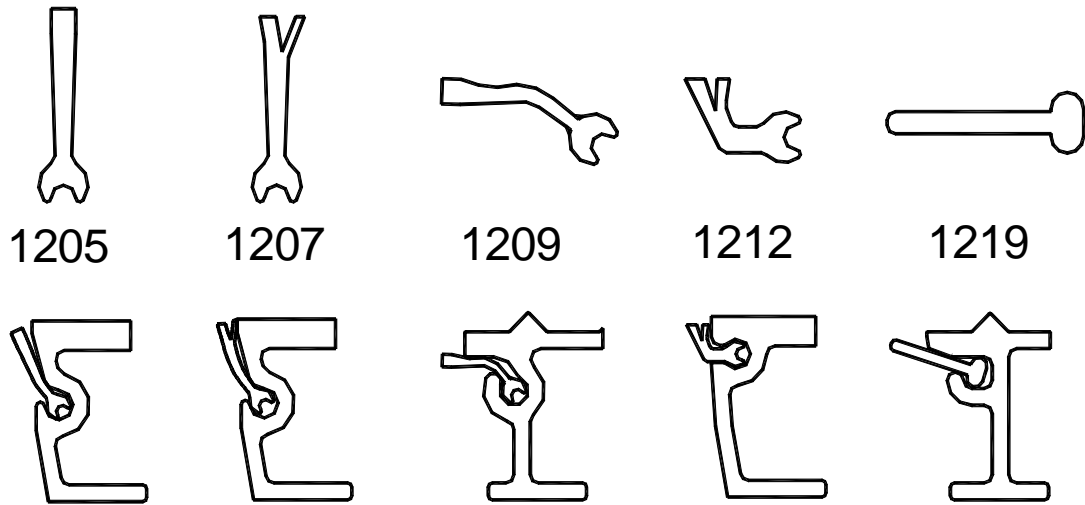

Side Seal

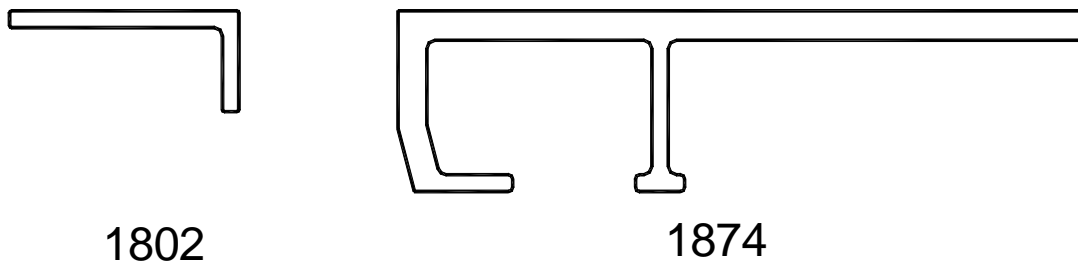

Subdeck

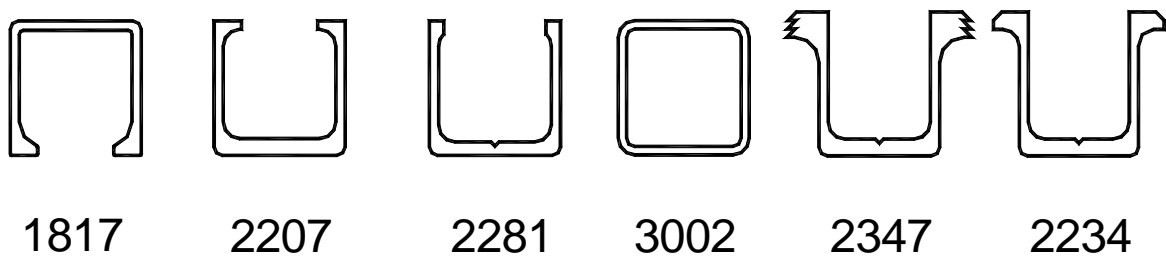

Plugs

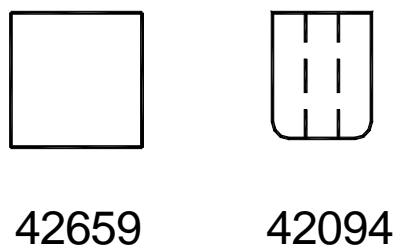

## Parts List

	ID#	DESCRIPTION	PART NUMBER*
<b>Seal</b>	1205	Seal Floor Standup	83120500
	1207	Seal Floor Standup "Y"	83120700
	1209	Seal Floor Horizontal	83120900
	1212	Seal Floor Bent "Y"	83121200
	1219	Seal Floor Hammer	83121900
<b>Side Seal</b>	1802	Slat 1/8" Side Seal Without Seal Slot	8218020000
	1874	Slat 7/32" Side Seal With Leg	8218740000
<b>Subdeck</b>	1817	Subdeck 1"x1"x.070" Wall Aluminum	8218170000
	2207	Subdeck 1"x1" Aluminum Thick Base	8222070000
	2281	Subdeck 1"x1" Aluminum Huckable	8222810000
	3002	Subdeck 1"x1"x.063"x20' Steel Tube	80300200
	2234 <sup>(1)</sup>	Subdeck Pressure Seal <sup>®</sup> Snapdown Aluminum	8222340000
	2347 <sup>(1)</sup>	Subdeck Pressure Seal <sup>®</sup> Serrated Snapdown Aluminum	8223470000
<b>Plugs</b>	42659	Plug Subdeck Steel 1"x1"x1/8"	04265901
	42094	Plug Pressure Seal <sup>®</sup> Floor Aluminum Hold Down	04209401

(1) 2347 is the replacement for 2234 (discontinued 3/02) and can only be used with bearing 2346.

\*The last four digits in the ten digit part number refers to length in feet and inches (Example: 8218024305 is 43'05" long).

### Bearings

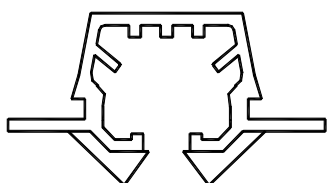

3003

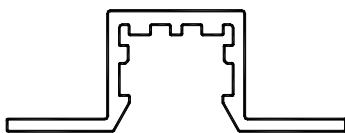

2228

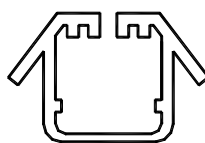

3004

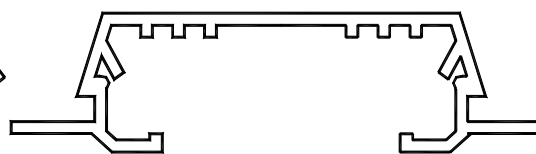

3030

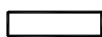

1000

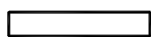

1500

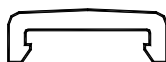

2235

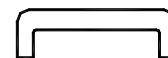

2346

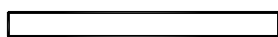

42036

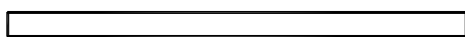

42037

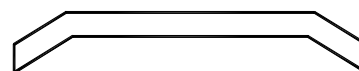

42045

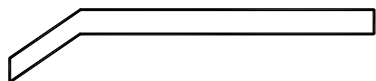

42046



2011

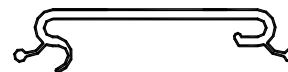

2146

### Hold Downs & "T" Blocks

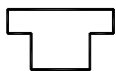

36928

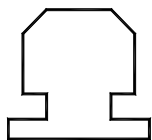

37804



11835

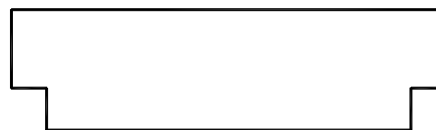

12172

## Parts List

	ID#	DESCRIPTION	PART NUMBER*
<b>Bearings</b>	3003	Bearing 3.5" Floor Slat	00300301
	2228	Bearing 3.5" Slat Splash Guard Strip	83222800
	3004	Bearing Hold Down 3.5" Floor Slat	00300401
	3030	Bearing 6.0" Floor Slat	00303001
	1000	Bearing 1" Wide Pressure Seal® Floor	83245500
	1500	Bearing 1.5" Wide Pressure Seal® Floor	83245600
	2235 <sup>(1)</sup>	Bearing Pressure Seal® Snap Down 50' Strip	83223500
	2346 <sup>(1)</sup>	Bearing Pressure Seal® Serrated Snap Down 50' Strip	83234601
	42036	Wear Pad UHMW 3.5" Floor	04203601
	42037	Wear Pad UHMW 6.0" Floor	04203701
	42045	Wear Pad 3.5" Floor Double Break	04204501
	42046	Wear Pad 3.5" Floor Single Break	04204601
	2011	Bearing 2011 13' 4" LP90 Drilled	04436701
	2146	Bearing 2146 13' 9" LP94 Drilled	03213801
	<b>Hold down</b>	36928	Bearing "T" Block Pressure Seal® Hold Down
<b>"T" Blocks</b>	37804	Bearing "T" Block Winged Pressure Seal®	03780401
	11835	Bearing "T" Block 3.5" Floor Slat	01183501
	12172	Bearing "T" Block 6.0" Floor Slat	01217201

(1) 2346 is the replacement for 2235 (discontinued 3/02) and can only be used with subdeck 2347.

1

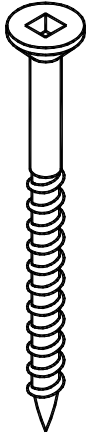

2

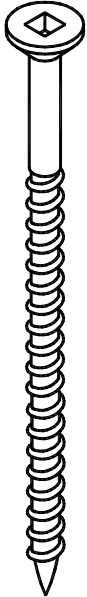

3

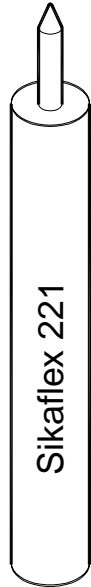

4

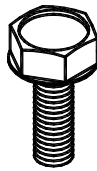

5

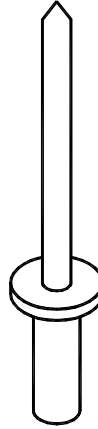

6

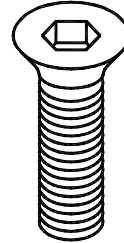

7

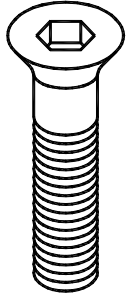

8

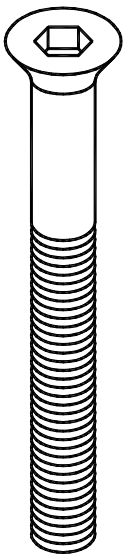

9

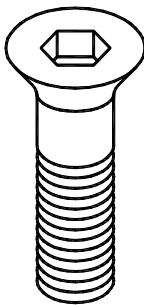

10

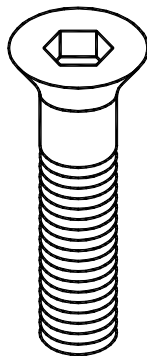

11

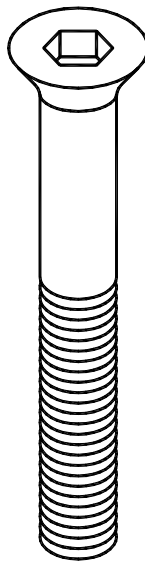

12

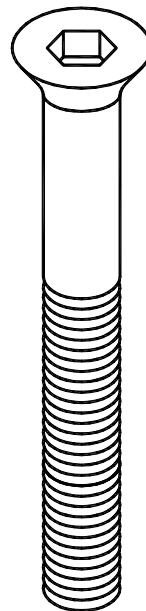

13

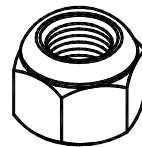

14

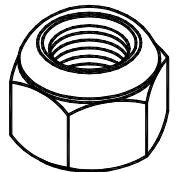

## Parts List

ID#	DESCRIPTION	PART NUMBER
1	Screw Stainless Steel Deck Seal #8x2"	86403000
2	Screw Stainless Steel Deck Seal #8x3"	86403100
3	Adhesive Sikaflex-221Black	83200900
4	Bolt Hex Washer Head Taptite #10-24x1/2" Zinc	86404500
5	Rivet Pop 1/8"x1/2"	86526400
6	Bolt Floor 5/16"x1" FHCS UNC	87402000
7	Bolt Floor 5/16"x1 1/4" FHCS UNC	87403000
8	Bolt Floor 5/16"x2 1/2" FHCS UNC	87407000
9	Bolt Floor 3/8"x1 1/4" FHCS UNC	87409000
10	Bolt Floor 3/8"x1 1/2" FHCS UNC	87410000
11	Bolt Floor 3/8"x2 1/2" FHCS UNC	87414000
12	Bolt Floor 3/8"x2 3/4" FHCS UNC	87415000
13	Nut Hex Nylock 5/16" UNC	86627500
14	Nut Hex Nylock 3/8" UNC	86628000

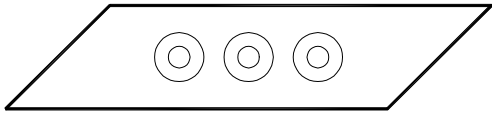

32303

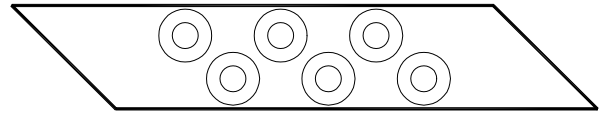

40511

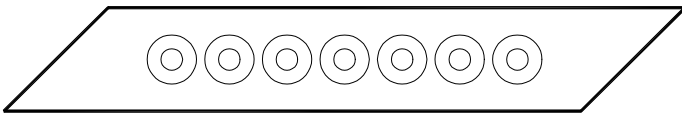

37656

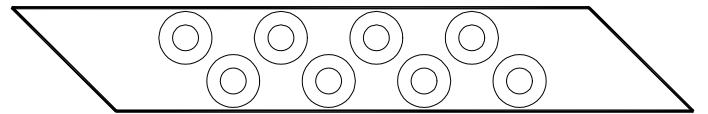

35571

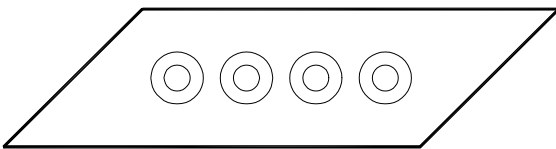

30188

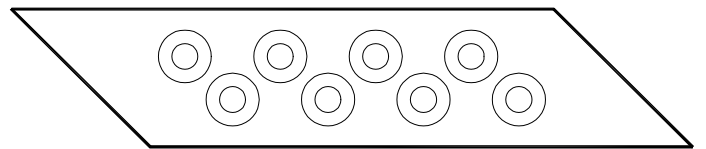

33751

**Parts List**

ID#	DESCRIPTION	PART NUMBER
32303	Bolt Plate 1/4"x1 1/2"x7" 3 Hole	03230301
37656	Bolt Plate Pressure Seal® 1/4"x1 1/2"x9 13/16" 7 Hole	03765601
30188	Bolt Plate 3/8"x2"x8" 4 Hole	03018801
40511	Bolt Plate 3/8"x1 1/2"x8 7/16" 6 Hole	04051101
35571	Bolt Plate 3/8"x1 1/2"x9 13/16" 8 Hole	03557101
33751	Bolt Plate 3/8"x2"x9 13/16" 8 Hole	03375101

## INSTRUCTIONS TO INSTALL FLOOR SEAL

WELD ON WEAR STRIPS AND FILLER  
PLATES BEFORE INSTALLING THE SEAL.

### STEP #1

PLACE THE BUNDLE OF FLOOR SLATS  
ON FOUR EQUALLY SPACED SAWHORSES.  
THE SAWHORSES MUST BE STRONG ENOUGH  
TO SUPPORT THE WEIGHT OF THE FLOOR SLATS.  
REMOVE THE BANDING FROM THE BUNDLE.

### STEP #2

INSPECT THE ENDS OF THE FLOOR  
SLATS. DE-BURR THE SEAL GROOVE.  
CHAMFER THE OUTSIDE EDGE OF THE  
FLOOR SLAT OPPOSITE THE SEAL GROOVE.  
DE-BURR AND CHAMFER BOTH  
ENDS OF THE FLOOR SLATS.

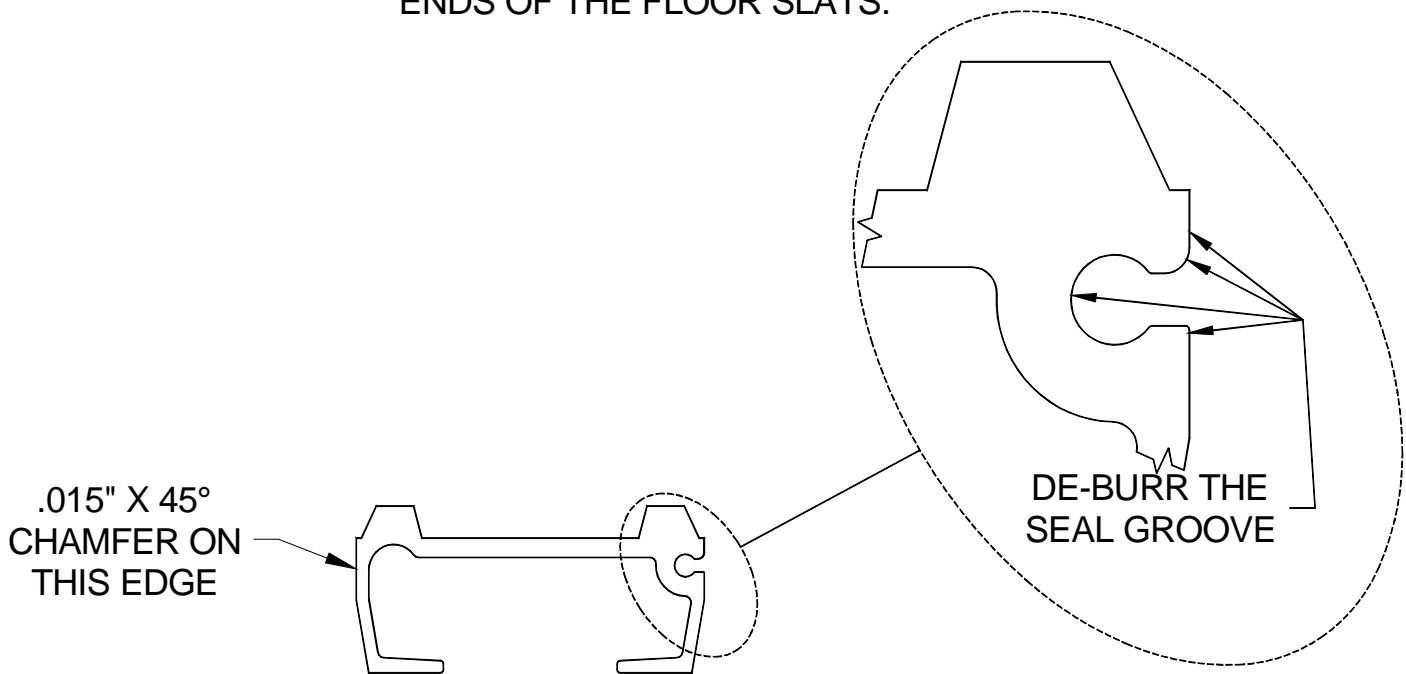

## INSTRUCTIONS TO INSTALL FLOOR SEAL

### STEP #3

PULL THE FLOOR SEAL INTO THE FLOOR SLAT. THE OPEN SIDE OF THE "Y" MUST BE TOWARD THE TOP OF THE FLOOR SLAT. PULL THE SEAL TO THE PROPER DISTANCE FROM THE END OF THE FLOOR SLAT AS SHOWN IN THE FIGURE BELOW\* (see table below). CUT THE SEAL OFF FLUSH WITH THE OTHER END OF THE FLOOR SLAT.

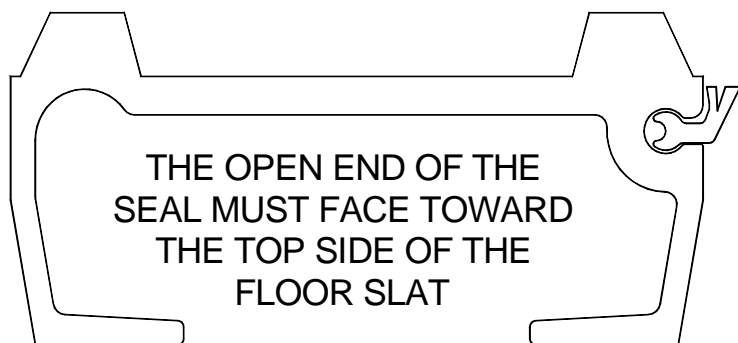

Trailer Length	Distance (from end of slat)
53'	19"-21"
48'	17"-19"
45'	16"-18"
40'	14"-16"
32'	11"-13"
27'	9"-11"
20'	7"-9"
BLUE SEAL	FLUSH

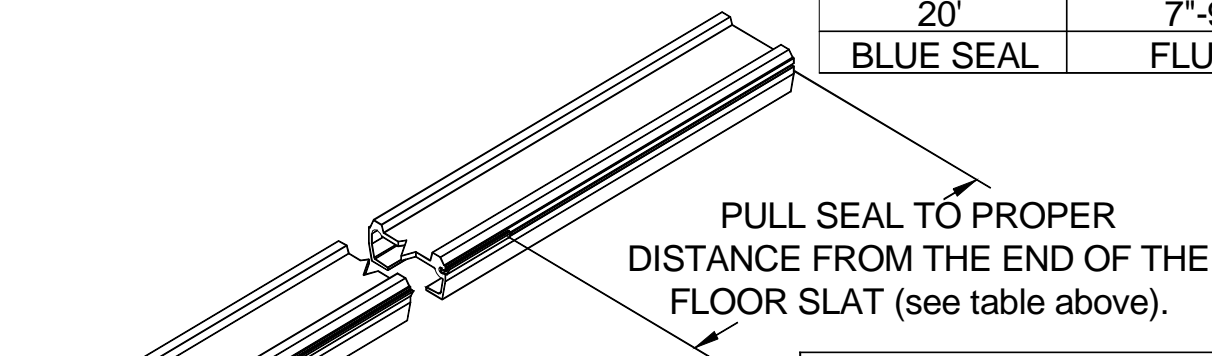

CUT THE SEAL FLUSH WITH THE OTHER END OF THE FLOOR SLAT

**\*NOTE:**  
BLUE SEAL IS NOT TO BE STRECHED  
-SEE INSET-

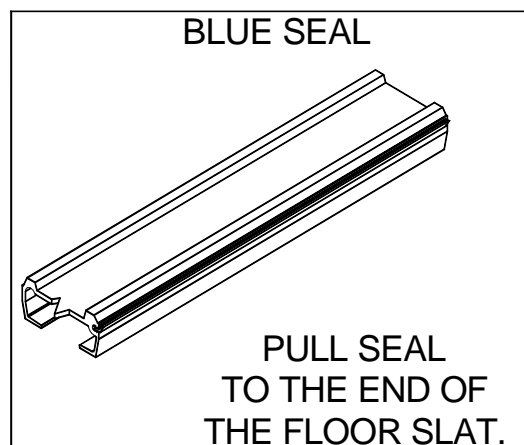

INSTRUCTIONS TO INSTALL  
FLOOR SEAL

STEP #4

APPLY A 1/8" DIAMETER BEAD OF SIKAFLEX 221 ADHESIVE SEALER INTO THE EXPOSED SEAL GROOVE (FROM THE END OF THE SEAL TO THE END OF THE SLAT). HOLD THE CAULKING GUN AT A 60° ANGLE TO THE FLOOR SLAT. (PUSH THE BEAD DO NOT PULL.)

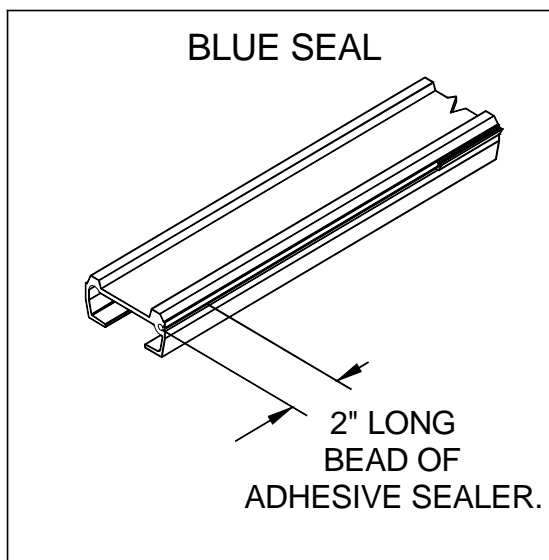
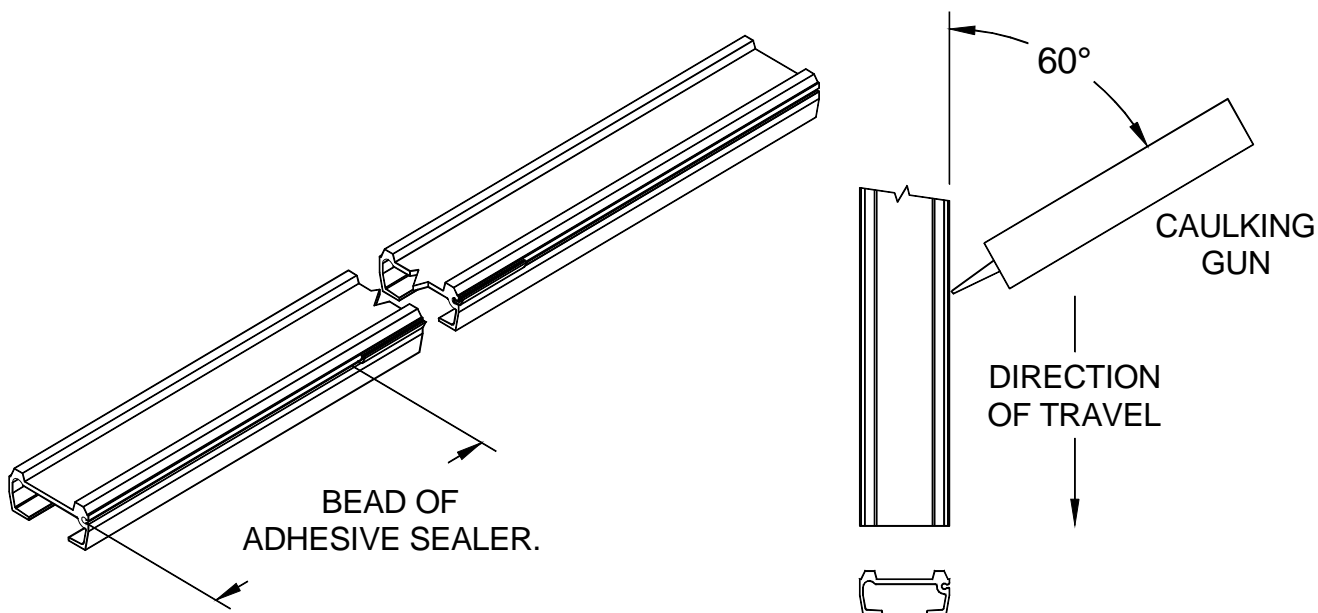

INSTRUCTIONS TO INSTALL  
FLOOR SEAL

STEP #5

PULL THE SEAL FLUSH WITH THE END OF THE SLAT. APPLY ADHESIVE TO THE ANCHOR SCREW. INSTALL THE ANCHOR SCREW. DO NOT TIGHTEN THE ANCHOR SCREW TOO TIGHTLY. ALLOW THE ADHESIVE TO DRY BEFORE INSTALLING THE SLAT.

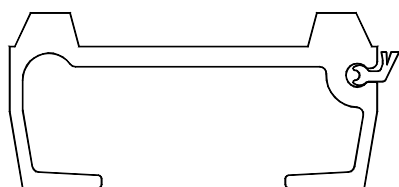

PULL THE SEAL OUTWARD  
WHEN PULLING IT THROUGH  
THE BEAD OF ADHESIVE.

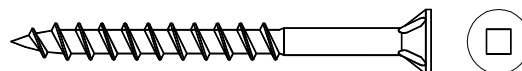
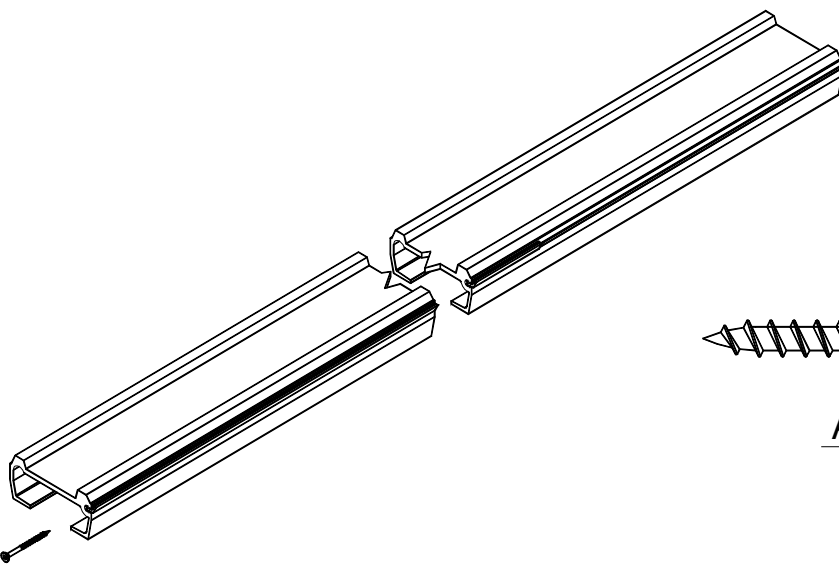

ANCHOR SCREW

ANCHOR  
SCREW

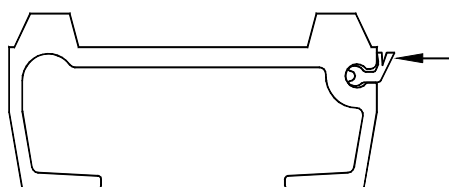

PUSH THE SEAL AGAINST  
THE SLAT AFTER INSTALLING  
THE ANCHOR SCREW.

COMPLETE STEPS #3, #4 AND #5 ON ALL THE SLATS IN THE BUNDLE. REPEAT STEPS #4 AND #5 TO THE OPPOSITE END OF ALL THE SLATS.

## INSTRUCTIONS TO TRIM A FLOOR SLAT TO LENGTH AFTER THE FLOOR SEAL HAS BEEN INSTALLED

### STEP #1

CUT THE FLOOR SLAT TO THE REQUIRED LENGTH. DO NOT DAMAGE THE FLOOR SEAL. THE REAR WEAR STRIPS AND FRONT FILLER STRIPS MUST BE REPLACED IF REMOVED BY SHORTENING THE FLOOR SLAT. IF THERE ARE WEAR STRIPS OR FILLER STRIPS INSTALLED ON THE SLAT, IT IS RECOMMENDED TO CUT OFF THE OPPOSITE END

### STEP #2

SLIDE THE LOOSE END OF THE FLOOR SEAL AWAY FROM THE END OF THE SLAT AS FAR AS POSSIBLE.

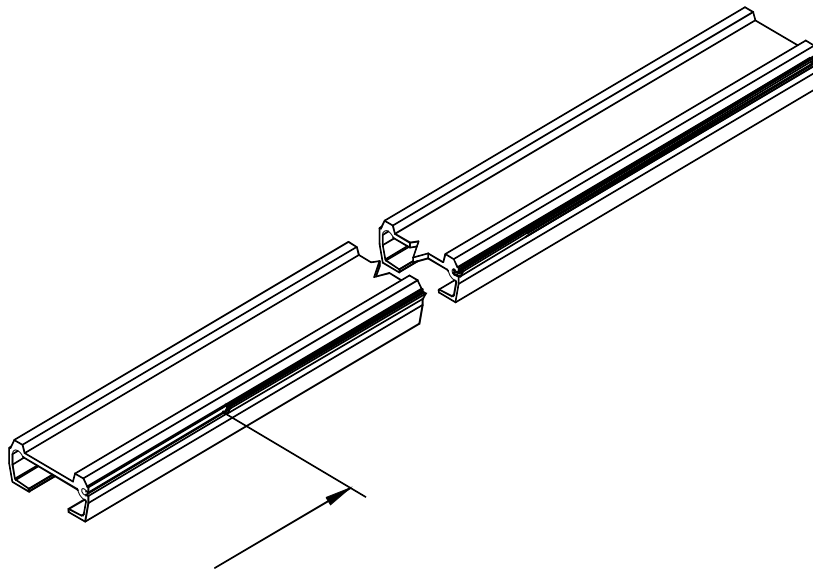

PUSH THE FLOOR SEAL  
AWAY FROM THE END

## INSTRUCTIONS TO TRIM A FLOOR SLAT TO LENGTH AFTER THE FLOOR SEAL HAS BEEN INSTALLED

### STEP #3

INSPECT THE ENDS OF THE FLOOR SLAT.  
DE-BURR THE SEAL GROOVE. CHAMFER  
THE OUTSIDE EDGE OF THE FLOOR SLAT  
OPPOSITE THE SEAL GROOVE.

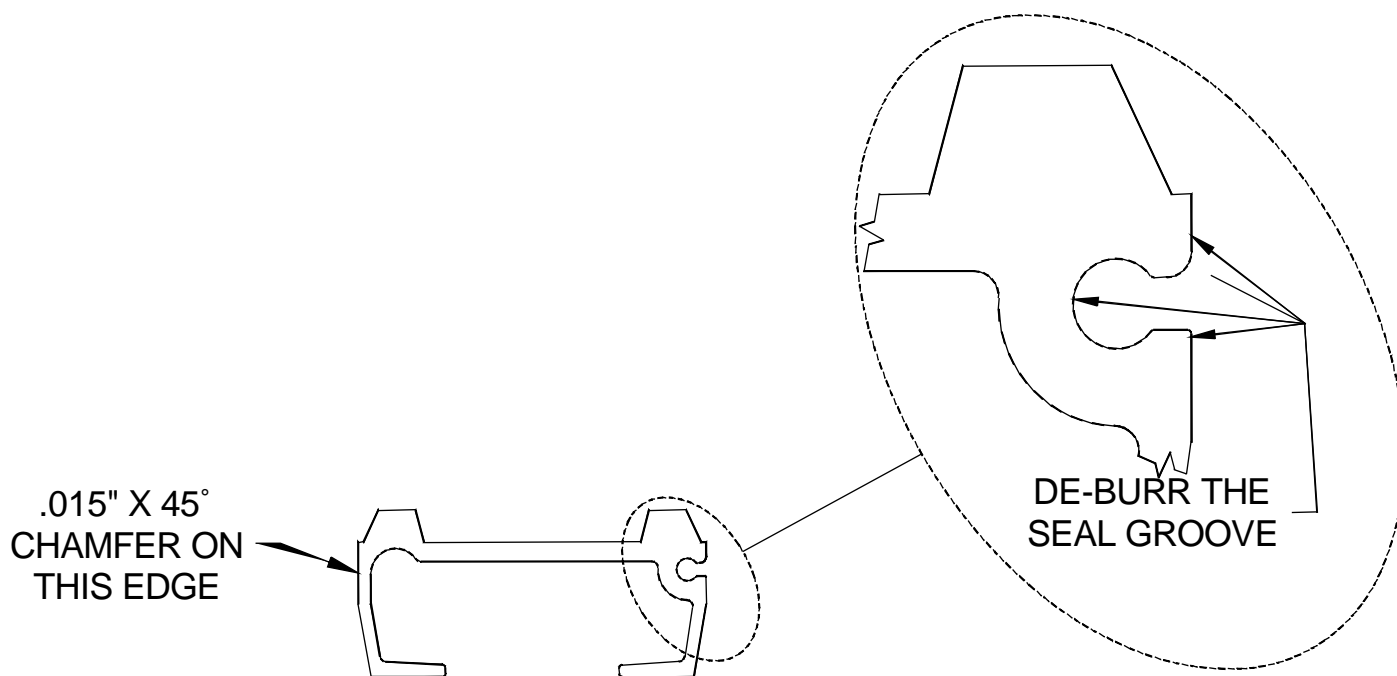

### STEP #4

WELD ON WEAR STRIPS OR FILLER STRIPS. SHIELD THE FLOOR SEAL  
FROM WELD SPLATTER. USE A HEAT SINK TO PREVENT DAMAGE TO  
THE FLOOR SEAL.

## INSTRUCTIONS TO TRIM A FLOOR SLAT TO LENGTH AFTER THE FLOOR SEAL HAS BEEN INSTALLED

### STEP #1

APPLY A 1/8" DIAMETER BEAD OF SIKAFLEX 221 ADHESIVE SEALER INTO THE EXPOSED SEAL GROOVE. THE BEAD SHOULD BE FROM THE END OF THE SEAL TO THE END OF THE SLAT. HOLD THE CAULKING GUN AT A 60° ANGLE TO THE FLOOR SLAT. PUSH THE BEAD. DO NOT PULL.

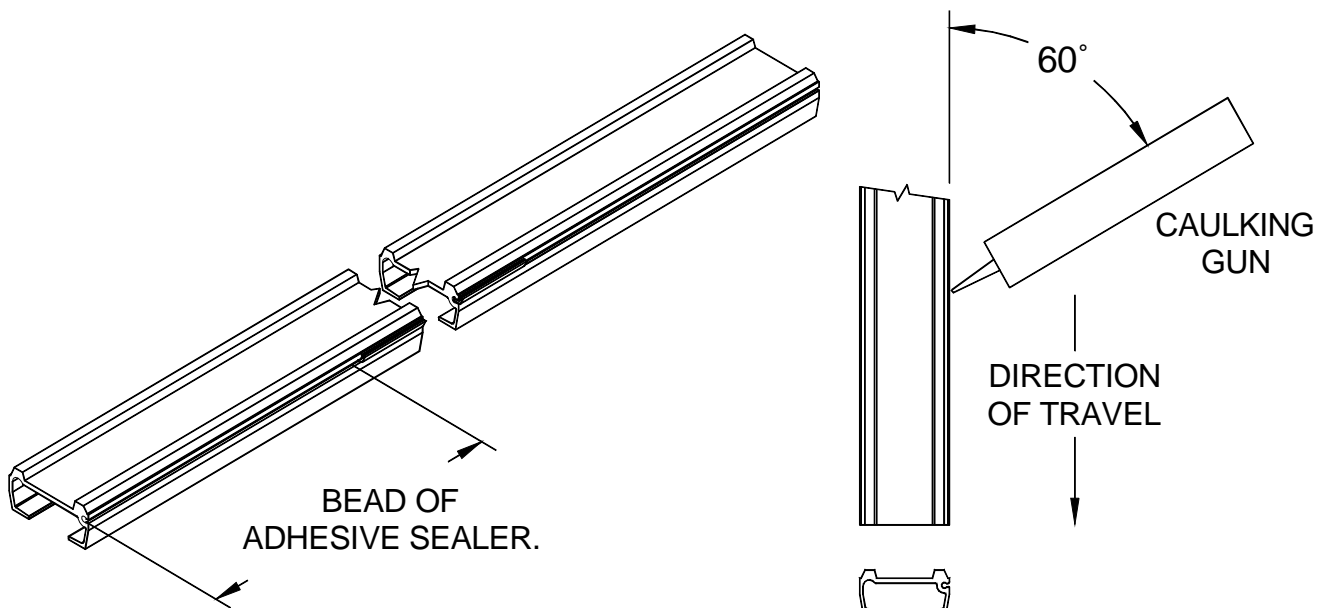

## INSTRUCTIONS TO TRIM A FLOOR SLAT TO LENGTH AFTER THE FLOOR SEAL HAS BEEN INSTALLED

### STEP #6

PULL THE SEAL FLUSH WITH THE END OF THE SLAT. APPLY ADHESIVE TO THE ANCHOR SCREW. INSTALL THE ANCHOR SCREW. DO NOT TIGHTEN THE ANCHOR SCREW TOO TIGHTLY. ALLOW THE ADHESIVE TO DRY BEFORE INSTALLING THE SLAT.

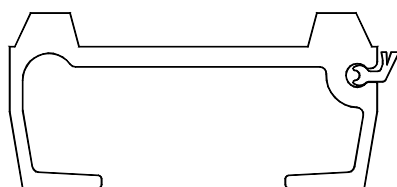

PULL THE SEAL OUTWARD  
WHEN PULLING IT THROUGH  
THE BEAD OF ADHESIVE.

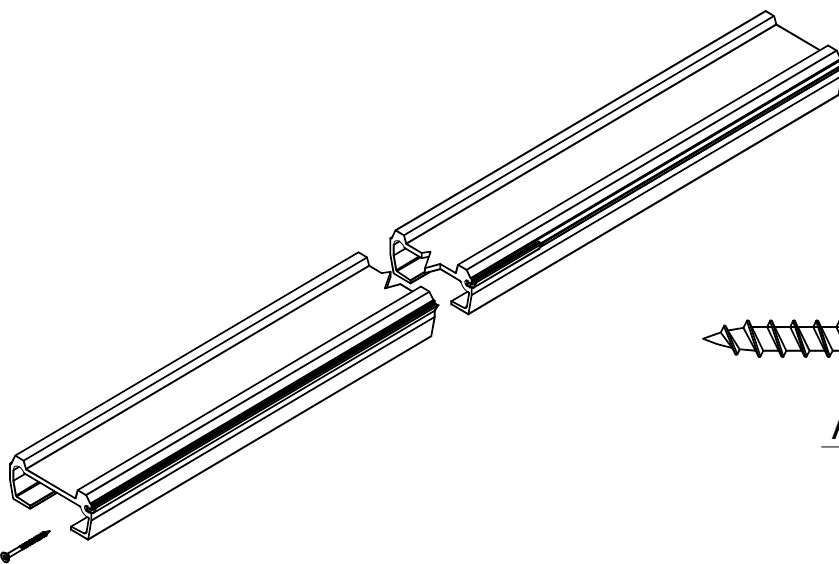

ANCHOR  
SCREW

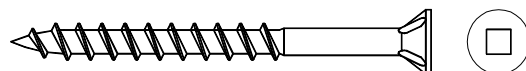

ANCHOR SCREW

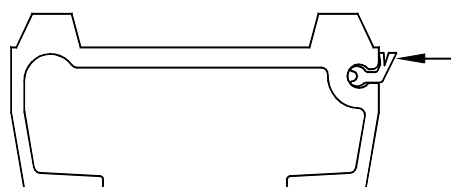

PUSH THE SEAL AGAINST  
THE SLAT AFTER INSTALLING  
THE ANCHOR SCREW.

## INSTRUCTIONS TO TRIM A FLOOR SLAT TO LENGTH AFTER THE FLOOR SEAL HAS BEEN INSTALLED

### STEP #7

A 24" LONG BEAD OF ADHESIVE SEALER IS REQUIRED BETWEEN THE SEAL AND THE FLOOR SLAT. PULL THE SEAL OUTWARD TO APPLY THE ADHESIVE. PRESS THE SEAL AGAINST THE FLOOR SLAT AFTER APPLYING THE ADHESIVE. ALLOW THE ADHESIVE TO DRY BEFORE INSTALLING THE FLOOR SLAT.

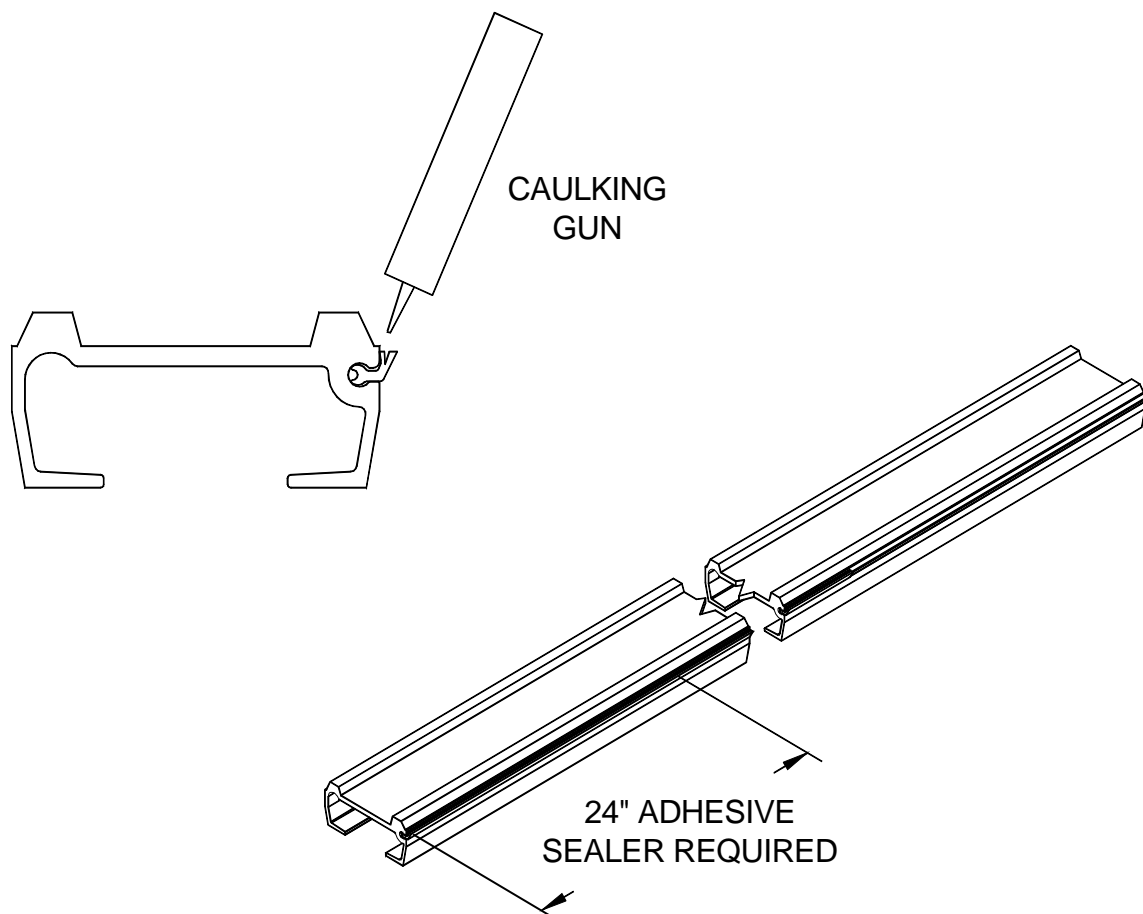

# Flooring Components Price List Prices in U.S. dollars

Prices Subject to Change Without Notice

ID#	DESCRIPTION	PART NUMBER*	PRICE
<b>3.5" Slats (1212 Seal)</b>		<b>Page 8.4</b>	
2216	Slat 3.5" 1/8" Smooth	8222160000	\$ 4.52
2217	Slat 3.5" 1/8" Smooth DS	8222170000	\$ 4.71
2185	Slat 3.5" 1/8" 2 Ridge	8221850000	\$ 4.59
2186	Slat 3.5" 1/8" 2 Ridge DS	8221860000	\$ 4.79
2188	Slat 3.5" 3/16" 4 Ridge	8221880000	\$ 5.63
2189	Slat 3.5" 3/16" 4 Ridge DS	8221890000	\$ 5.74
2203	Slat 3.5" 7/32" Smooth	8222030000	\$ 5.97
2204	Slat 3.5" 7/32" Smooth DS	8222040000	\$ 6.07
2190	Slat 3.5" 7/32" 6 Ridge	8221900000	\$ 6.19
2191	Slat 3.5" 7/32" 6 Ridge DS	8221910000	\$ 6.26
2199	Slat 3.5" 3/8" Smooth	8221990000	\$ 8.52
2200	Slat 3.5" 3/8" Smooth DS	8222000000	\$ 8.55
2295	Slat 3.5" 1914 1/2" Impact® Series 1212	8222950000	\$ 6.95
2296	Slat 3.5" 1913 1/2" Impact® Series DS 1212	8222960000	\$ 7.46
2299	Slat 3.5" 1914 CWS 1/2" Impact® Series 1212	8222990000	\$ 8.45
2300	Slat 3.5" 1913 CWS 1/2" Impact® Series DS 1212	8223000000	\$ 8.96
2297	Slat 3.5" 1841 3/4" Impact® Series 1212	8222970000	\$ 9.02
2298	Slat 3.5" 1890 3/4" Impact® Series DS 1212	8222980000	\$ 9.33
2301	Slat 3.5" 1841 CWS 3/4" Impact® Series 1212	8223010000	\$ 11.12
2302	Slat 3.5" 1890 CWS 3/4" Impact® Series DS 1212	8223020000	\$ 11.40
<b>6.0" &amp; 7.0" Slats (1212 Seal)</b>		<b>Page 8.6</b>	
2303	Slat 6.0" 1914 1/2" Impact® Series 1212	8223030000	\$ 10.33
2304	Slat 6.0" 1913 1/2" Impact® Series DS 1212	8223040000	\$ 10.92
2306	Slat 6.0" 1914 CWS 1/2" Impact® Series 1212	8223060000	\$ 13.04
2305	Slat 6.0" 1913 CWS 1/2" Impact® Series DS 1212	8223050000	\$ 13.64
2307	Slat 6.0" 1841 3/4" Impact® Series 1212	8223070000	\$ 14.12
2308	Slat 6.0" 1890 3/4" Impact® Series DS 1212	8223080000	\$ 14.48
<b>3.5", 6.0" &amp; 7.0" Slats (1207 Seal)</b>		<b>Page 8.8</b>	
2153	Slat 3.5" 1841 3/4" Impact® Series 1207	8221530000	\$ 9.02
2154	Slat 3.5" 1890 3/4" Impact® Series DS 1207	8221540000	\$ 9.06
2052	Slat 6.0" 1914 1/2" Impact® Series 1207	8220520000	\$ 10.33
2053	Slat 6.0" 1913 1/2" Impact® Series DS 1207	8220530000	\$ 11.06
2174	Slat 6.0" 1914 CWS 1/2" Impact® Series 1207	8221740000	\$ 13.47
2173	Slat 6.0" 1913 CWS 1/2" Impact® Series DS 1207	8221730000	\$ 13.40
2037	Slat 6.0" 1841 3/4" Impact® Series 1207	8220370000	\$ 14.90
2038	Slat 6.0" 1890 3/4" Impact® Series DS 1207	8220380000	\$ 14.97
2031	Slat 7.0" 3/4" Impact® Series 1207	8220310000	\$ 16.96
2032	Slat 7.0" 3/4" Impact® Series DS 1207	8220320000	\$ 17.04

<b>Leak Proof Slat/Subdeck Combination</b>		<b>Page 8.10</b>	
2167	Subdeck LP94	8221670000	\$ 14.06
2145	Slat 3.5" LP94 19/32" Impact® Series	8221450000	\$ 7.16
2010	Subdeck LP90	8220100000	\$ 11.22
2007	Slat 7.0" LP90 3/4" Impact® Series	8220070000	\$ 14.67
<b>Hammer Seal Slats/Pressure Seal Slats</b>		<b>Page 8.11</b>	
2193	Slat 3.5" 1/8" Smooth Pressure Seal®	8221930000	\$ 4.08
2236	Slat 3.5" 1/8" 2 Ridge Pressure Seal®	8222360000	\$ 4.12
2195	Slat 3.5" 3/16" 4 Ridge Pressure Seal®	8221950000	\$ 5.14
2271	Slat 3.5" 3/16" 4 Ridge Hammer Seal	8222710000	\$ 5.50
2272	Slat 3.5" 3/16" 4 Ridge Hammer Seal DS	8222720000	\$ 5.72
2293	Slat 3.5" 7/32" 6 Ridge Hammer Seal	8222930000	\$ 6.62
2294	Slat 3.5" 7/32" 6 Ridge Hammer Seal DS	8222940000	\$ 6.88
<b>Seals, Side Seals, Subdecks &amp; Plugs</b>		<b>Page 8.12</b>	
1205	Seal Floor Standup	83120500	\$ 0.65
1207	Seal Floor Standup "Y"	83120700	\$ 0.65
1209	Seal Floor Horizontal	83120900	\$ 0.65
1212	Seal Floor Bent "Y"	83121200	\$ 0.65
1219	Seal Floor Hammer	83121900	\$ 0.65
1802	Slat 1/8" Side Seal Without Seal Slot	8218020000	\$ 1.43
1874	Slat 7/32" Side Seal With Leg	8218740000	\$ 8.08
1817	Subdeck 1"x1"x.070" Wall Aluminum	8218170000	\$ 1.16
2207	Subdeck 1"x1" Aluminum Thick Base	8222070000	\$ 1.33
2281	Subdeck 1"x1" Aluminum Huckable	8222810000	\$ 1.15
3002	Subdeck 1"x1"x.063"x20' Steel Tube	80300200	\$ 25.00
2234	Subdeck Pressure Seal® Snapdown Aluminum	8222340000	\$ 1.46
2347	Subdeck Pressure Seal® Serrated Snapdown Aluminum	8223470000	\$ 1.68
2469	SUBDECK SPLASHGUARD HOLDDOWN	8224690000	\$ 1.32
42659	Plug Subdeck Steel 1"x1"x1/8"	04265901	\$ 1.12
42094	Plug Pressure Seal® Floor Aluminum Hold Down	04209401	\$ 16.91
<b>Bearings, Hold Downs &amp; "T" Blocks</b>		<b>Page 8.14</b>	
3003	Bearing 3.5" Floor Slat	00300301	\$ 1.28
2228	Bearing 3.5" Slat Splash Guard Strip	83222801	\$ 14.90
2468	SPLASHGUARD HOLDDOWN 6' LENGTH	83246801	\$ 11.13
3004	Bearing Hold Down 3.5" Floor Slat	00300401	\$ 1.28
3030	Bearing 6.0" Floor Slat	00303001	\$ 2.65
1000	Bearing 1" Wide Pressure Seal® Floor	83245500	\$ 103.16
1500	Bearing 1.5" Wide Pressure Seal® Floor	83245600	\$ 89.21
2235	Bearing Pressure Seal® Snap Down 50' Strip	83223500	\$ 75.73
2346	Bearing Pressure Seal® Serrated Snap Down 50' Strip	83234600	\$ 50.78

# Flooring Components Price List Prices in U.S. dollars

Prices Subject to Change Without Notice

42036	Wear Pad UHMW 3.5" Floor	04203601	\$ 4.06
42037	Wear Pad UHMW 6.0" Floor	04203701	\$ 6.29
42045	Wear Pad 3.5" Floor Double Break	04204501	\$ 5.80
42046	Wear Pad 3.5" Floor Single Break	04204601	\$ 5.52
2011	Bearing 2011 13' 4" LP90 Drilled	04436701	\$ 38.23
2146	Bearing 2146 13' 9" LP94 Drilled	03213801	\$ 39.34
36928	Bearing "T" Block Pressure Seal® Hold Down	03692801	\$ 1.41
37804	Bearing "T" Block Winged Pressure Seal®	03780401	\$ 34.62
11835	Bearing "T" Block 3.5" Floor Slat	01183501	\$ 11.32
12172	Bearing "T" Block 6.0" Floor Slat	01217201	\$ 30.41
<b>Fasteners Page 8.16</b>			
1	Floor Seal Screw #8x2" Stainless Steel	86403000	\$ 0.13
2	Floor Seal Screw #8x3" Stainless Steel	86403100	\$ 0.22
3	Adhesive Sikaflex-221Black	83200900	\$ 10.18
4	Bolt Hex Washer Head Taptite #10-24x1/2" Zinc	86404500	\$ 0.07
5	Rivet Pop 1/8"x1/2"	86526400	\$ 0.04
6	Bolt Floor 5/16"x1" FHCS UNC	87402000	\$ 0.53
7	Bolt Floor 5/16"x1 1/4" FHCS UNC	87403000	\$ 0.55
8	Bolt Floor 5/16"x2 1/2" FHCS UNC	87407000	\$ 1.17
9	Bolt Floor 3/8"x1 1/4" FHCS UNC	87409000	\$ 0.60
10	Bolt Floor 3/8"x1 1/2" FHCS UNC	87410000	\$ 0.66
11	Bolt Floor 3/8"x2 1/2" FHCS UNC	87414000	\$ 0.88
12	Bolt Floor 3/8"x2 3/4" FHCS UNC	87415000	\$ 0.93
13	Nut Hex Nylock 5/16" UNC	86627500	\$ 0.04
14	Nut Hex Nylock 3/8" UNC	86628000	\$ 0.15
<b>Bolt Plates Page 8.18</b>			
32303	Bolt Plate 1/4"x1 1/2"x7" 3 Hole	03230301	\$ 7.29
37656	Bolt Plate Pressure Seal® 1/4"x1 1/2"x9 13/16" 7 Hole	03765601	\$ 17.13
30188	Bolt Plate 3/8"x2"x8" 4 Hole	03018801	\$ 10.45
40511	Bolt Plate 3/8"x1 1/2"x8 7/16" 6 Hole	04051101	\$ 6.90
35571	Bolt Plate 3/8"x1 1/2"x9 13/16" 8 Hole	03557101	\$ 9.75
33751	Bolt Plate 3/8"x2"x9 13/16" 8 Hole	03375101	\$ 8.26